



**LUMINES**<sup>®</sup>  
Design+

aria  
LUMINES

## The art of creation

LUMINES Design+ to topowa seria profili aluminiowych od LUMINES Lighting, która łączy w sobie najwyższą jakość wykonania, funkcjonalność oraz nowoczesne rozwiązania konstrukcyjne, utrzymane w eleganckim, minimalistycznym designie. Kolekcja umożliwia Architektom i Projektantom tworzenie unikalnych struktur świetlnych, które podkreślają charakter i wyrafinowanie projektu. Dzięki rozszerzonej paletce kolorystycznej, dostosowanej do najnowszych trendów wzornictwa i architektury wnętrz, LUMINES Design+ oferuje niezrównaną wszechstronność, idealną dla wymagających, spersonalizowanych realizacji.

LUMINES Design+ is a premium series of aluminum profiles from LUMINES Lighting, combining the highest quality craftsmanship, functionality, and modern design solutions, all wrapped in an elegant, minimalist aesthetic. This collection empowers architects and designers to create unique lighting structures that enhance the character and sophistication of their projects. With an expanded color palette tailored to the latest trends in design and interior architecture, LUMINES Design+ offers unparalleled versatility, perfect for demanding, personalized applications.

# aria

Profil LED | Seria **LUMINES Design+** / LED profile | **LUMINES Design+** Series

## PL

Profil LED napowierzchniowy lub zwieszany przeznaczony do podświetlenia głównego. Dzięki zastosowaniu łączników prostych oraz kątowych umożliwia tworzenie unikalnych struktur świetlnych.

### Innowacje LUMINES:

- zminimalizowana grubość bocznych krawędzi – profil staje się „niewidoczny” tworząc linię światła o wysokiej estetyce i elegancji,
- klosz FRACTAL zapewnia jednolitą dyfrakcję światła,
- łączniki ukryte w konstrukcji profilu,
- mocowanie zawiesi ukryte w konstrukcji profilu,
- specjalna budowa dna umożliwia zrównanie śrub montażowych z linią dna profilu – po wykonaniu otworów z pogłębieniem stożkowym,
- efektywniejsze odprowadzenie ciepła wydłuża żywotność źródeł światła – dzięki zwiększonej grubości dna profilu,
- zaślepki aluminiowe bez widocznych wkrętów – jednolita gładka powierzchnia,
- rozszerzona paleta kolorystyczna Design+: profile + zaślepki, chromowane uchwyty.

## EN

A surface-mounted or suspended LED profile designed for primary lighting. With straight and angular connectors, it enables the creation of unique lighting structures.

### LUMINES Innovations:

- minimized side edge thickness – the profile becomes "invisible", creating a high-aesthetic and elegant light line,
- FRACTAL cover ensures uniform light diffraction,
- connectors hidden within the profile structure,
- suspension mounts hidden within the profile structure,
- special base design allows mounting screws to align with the profile base – achieved through countersunk holes,
- enhanced heat dissipation extends the lifespan of the light source – thanks to the increased base thickness,
- aluminum end caps without visible bolts – flat, uniform surface,
- expanded Design+ color palette: profiles + end caps, chrome-plated handles.

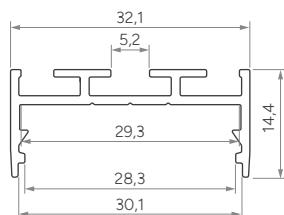









Sposoby montażu /  
Assembly methods



**Profile LED / LED Profiles**

Długość (mm) / Length (mm): 1000, 2020, 3000





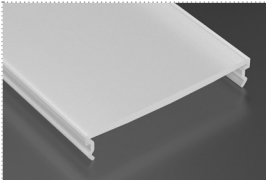
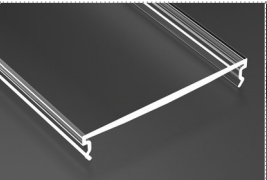
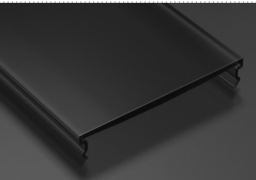

	SREBRNY (anodowany) silver (anodized)	CZARNY (anodowany) black (anodized)	CZARNY (lakierowany) black (lacqured)	BIAŁY (lakierowany) white (lacqured)	SUROWY raw
<b>Kolory profili</b> Profile colors					
1,0 m	10-1424-10	10-1422-10	10-1425-10	10-1421-10	10-1420-10
2,02 m	10-1424-20	10-1422-20	10-1425-20	10-1421-20	10-1420-20
3,0 m	10-1424-30	10-1422-30	10-1425-30	10-1421-30	10-1420-30
	<b>Rock Anthracite   RAL 7016</b>	<b>Reed Green   RAL 6013</b>	<b>Sky Blue   RAL 220 70 10</b>	<b>Light Ivory   RAL 1015</b>	
<b>Kolory profili</b> Profile colors					
1,0 m	10-1429-10	10-1428-10	10-1427-10	10-1426-10	
2,02 m	10-1429-20	10-1428-20	10-1427-20	10-1426-20	
3,0 m	10-1429-30	10-1428-30	10-1427-30	10-1426-30	
<b>Szerokość taśmy LED (mm)</b> LED strip width (mm)	2 × 12				

**Klosze (PC) / Covers (PC)**

Długość (mm) / Length (mm): 1000, 2020, 3000

OPAL	CLEAR	BLACK
<b>midi</b>		
		
1 m PC: 11-3401-10	1 m PC: 11-3403-10	1 m PC: 11-3407-10

**Dodatki / Accessories**

UCHWYT SLT SLT mounting clip	ŁĄCZNIK PROSTY straight connector	ŁĄCZNIK KĄTOWY 90° angular connector 90°	ŁĄCZNIK POPRZECZNY KĄTOWY angular transverse connector	ŁĄCZNIK KĄTOWY 120° angular connector 120°	UCHWYT NA PRZEWÓD Ø 5 mm cable Ø 5 mm holder	ZAWIESIA pendants
						
13-0000-02	14-3032-02	14-3030-01	14-3038-01	14-3036-01	*T 14-7067-00 *B 14-7067-02	*S 14-2011-02 *B 14-2076-00 *W 14-2075-00

\* S SREBRNY silver; \* B CZARNY black; \* T TRANSPARENTNY transparent; \* W BIAŁY white

## Zaślepki (aluminium i tworzywo sztuczne) / End caps (aluminum and plastic)

BEZ OTWORU (TWORZYWO SZTUCZNE) without a hole (plastic)							
<b>SREBRNY</b> silver	<b>CZARNY</b> black	<b>BIAŁY</b> white	<b>SZARY</b> grey	<b>Rock Anthracite</b> RAL 7016	<b>Reed Green</b> RAL 6013	<b>Sky Blue</b> RAL 220 70 10	<b>Light Ivory</b> RAL 1015
							
12-1525-01	12-1522-01	12-1521-01	12-1524-01	12-1529-01	12-1526-01	12-1527-01	12-1528-01
BEZ OTWORU (ALUMINIUM ANODOWANE) without a hole (aluminium anodized)							
<b>SREBRNY</b> silver	<b>CZARNY</b> black						
							
12-1525-11	12-1522-11						
BEZ OTWORU (ALUMINIUM LAKIEROWANE) without a hole (aluminium lacquered)							
	<b>CZARNY</b> black	<b>BIAŁY</b> white		<b>Rock Anthracite</b> RAL 7016	<b>Reed Green</b> RAL 6013	<b>Sky Blue</b> RAL 220 70 10	<b>Light Ivory</b> RAL 1015
							
	12-1522-21	12-1521-11		12-1529-11	12-1526-11	12-1527-11	12-1528-11

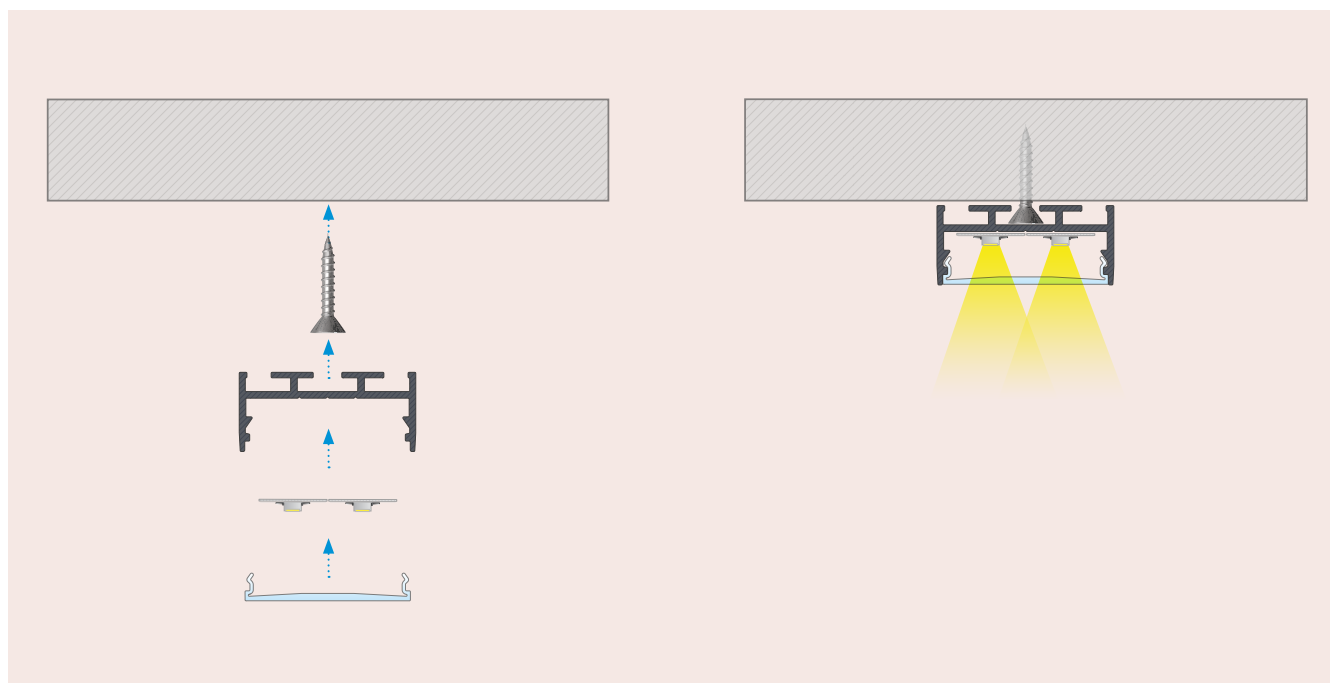

### PL

Instrukcja montażu profilu LED aria z kloszem midi za pomocą wkrętu montażowego.

### EN

Installation instructions for the aria LED profile with a midi cover using mounting screw.

### PL

Efekt końcowy montażu profilu LED aria z kloszem midi za pomocą wkrętu montażowego.

### EN

The result of the installation of the aria LED profile with a midi cover using mounting screw.

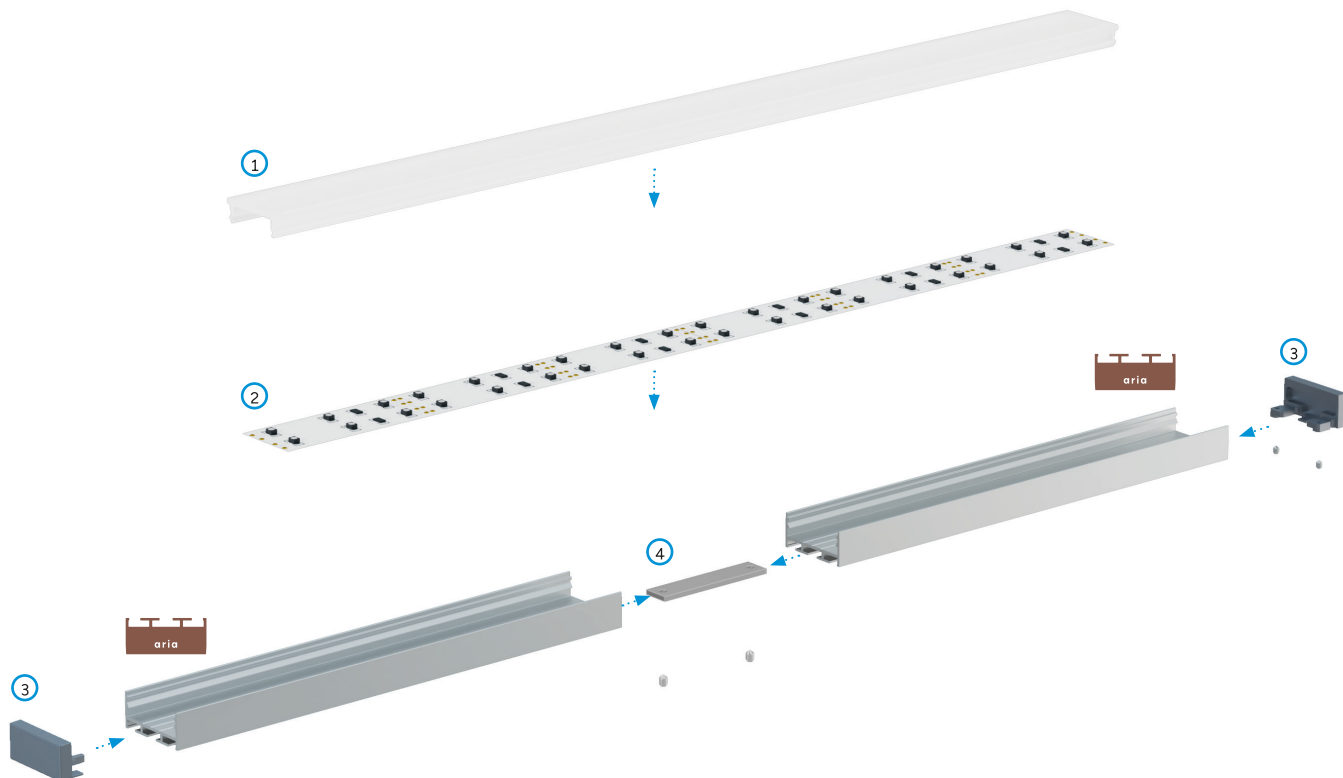

**PL**

Schemat złożenia elementów systemu oświetleniowego LED z wykorzystaniem profilu LED aria oraz (1) klosza midi, (2) dwóch taśm LED, (3) zaślepek końcowych, (4) łącznika prostego.

**EN**

Assembly scheme for elements of the LED lighting system using the aria LED profile and (1) a midi cover, (2) two LED strips, (3) end caps, (4) a straight connector.



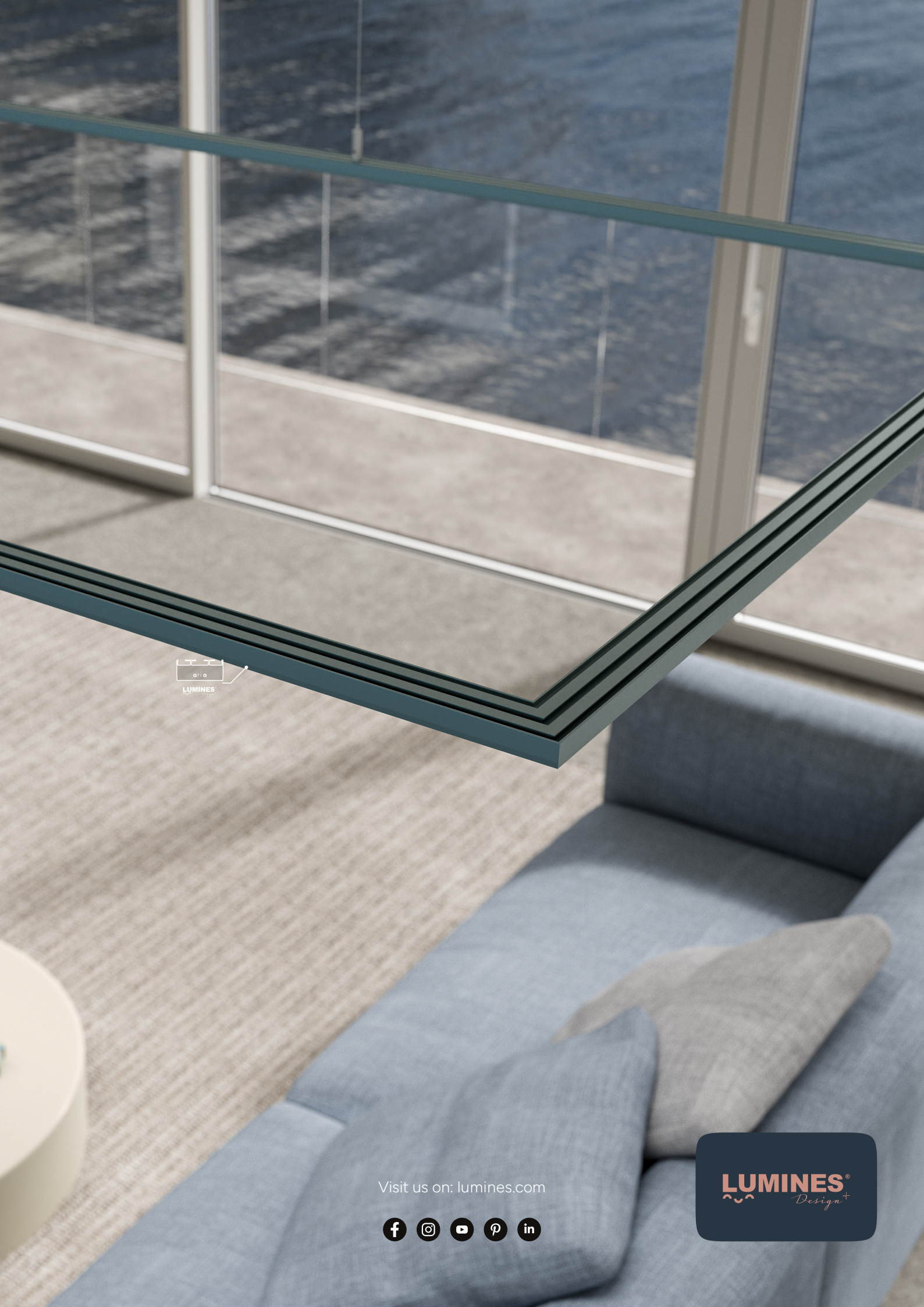

aria  
LUMINES

Visit us on: [lumines.com](https://lumines.com)

